

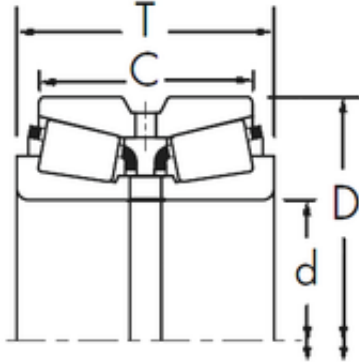

BEARING TYCA PRIVATE LTD.

Timken 641/632D+X1S-641 tapered roller bearings



Bearing No. 641/632D+X1S-641

Size	66.675x136.525x95.25 mm
Bore Diameter	66,675 mm
Outer Diameter	136,525 mm
Width	95,25 mm
d	66,675 mm
D	136,525 mm
T	95,25 mm
C	76,2 mm
R	3,5 mm
r	1,5 mm

641/632D+X1S-641 Bearing 2D drawings and 3D CAD models